

TAISYNC

Taisync

User Manual

www.taisync.com

Contents

1.	Packet Contents	1
2.	Product Description	3
2.1.	Parameters	3
2.2.	Air Unit Interfaces	3
2.3.	Ground Unit Interfaces	5
3.	Installation	8
3.1.	Air Unit Installation	8
3.1.1.	Antenna installation	8
3.1.2.	Power supply	9
3.1.3.	Connection to camera	10
3.1.4.	Connection to flight controller (RC & telemetry)	11
3.2.	Ground Unit Installation	12
3.2.1.	Antenna installation	12
3.2.2.	Power supply	12
3.2.3.	Telemetry connection	13
3.2.4.	Connection to remote controller	14
3.2.5.	Setup video output	15
3.2.6.	Use Taisync system	16
4.	Software	18
4.1.	Installation	18
4.2.	Software Language	20
4.3.	Device Info	21
4.4.	Status	22
4.5.	Configuration	24
4.5.1.	Encryption configuration	24
4.5.2.	Mode configuration	24
4.5.3.	Baud rate configuration	26
4.5.4.	Telemetry configuration	26
4.5.5.	Remote control mode configuration	27
4.6.	Frequency Scan	27
4.7.	Upgrade	28
4.8.	View Live Video	29
4.8.1.	On phone/tablet	29
4.8.2.	On monitor	29
5.	Applications	30
5.1.	Applications of system in detail	30

5.2.	Applications of RC	30
5.2.1.	FRSKY remote controller.....	31
5.2.2.	Futaba remote controller.....	31
5.3.	Telemetry connection.....	32
5.4.	Video output on USB (standard).....	32
6.	Notes.....	32
6.1.	Link performance.....	32
6.2.	How to select Frequency.....	34
6.3.	Firmware update	36
6.4.	Bind operation.....	37
6.5.	Telemetry & RC.....	38
7.	FAQ.....	38

1. Packet Contents

Air Unit & Ground Unit

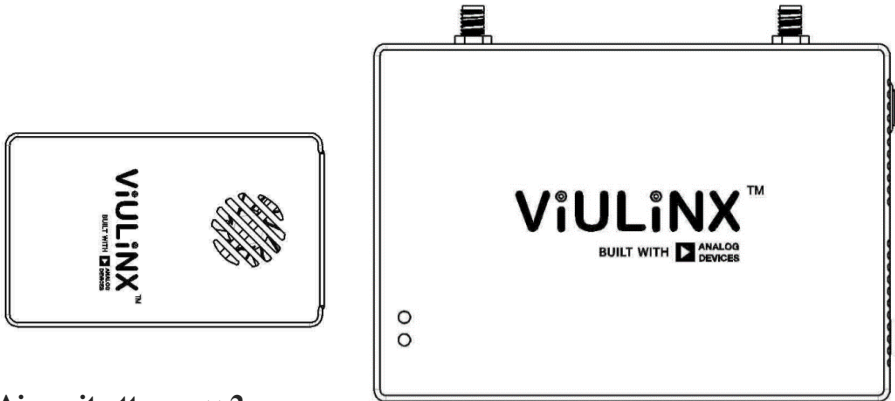

Air unit antenna × 2



(2.4G antenna for air unit)

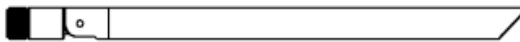

(1.4G antenna for ground unit)

Ground unit antenna × 2





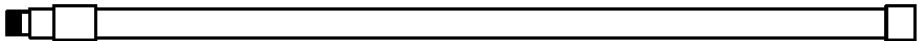

(2.4G antenna for ground unit)



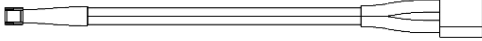

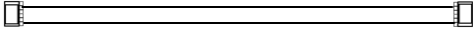
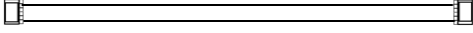

(1.4G antenna for ground unit)

Air Unit Cables

Power cable x1	
This is used to connect the output of a battery to the power input of the air unit.	
RJ45 cable x1	

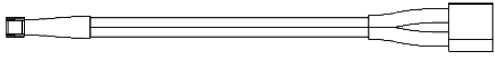
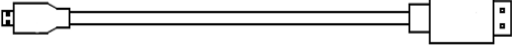
<p>This is used to connect the ETH output of camera to the ETH input of the air unit.</p>	
<p>RC cable x1</p>	
<p>This is used to connect the PPM/S.bus port of flight controller to the RC port of the air unit.</p>	
<p>Serial cable (UART) x1</p>	
<p>This is used to connect the telemetry port of flight controller to the serial port of the air unit.</p>	
<p>USB cable (Micro to Type-A) x1</p>	
<p>This is used to connect the USB port of a PC or a cell phone, to the Micro USB port of the ground unit.</p>	

Ground Unit Cables

<p>Power cable x1</p>	
<p>This is used to connect the output of a battery to the power input of the air unit.</p>	
<p>HDMI cable (Type C-Type A) x1</p>	
<p>This is used to connect the HDMI output of ground unit to the HDMI input of the monitor.</p>	
<p>RC cable x1</p>	
<p>This is used to connect the training port of a remote controller to the RC port of the ground unit.</p>	
<p>Serial cable (UART) x1</p>	
<p>This is used to connect the telemetry port of ground station to the serial port of the ground unit.</p>	
<p>USB cable (Micro to Type-A) x1</p>	
<p>This is used to connect the USB port of a PC or a cell phone, to</p>	

the Micro USB port of the ground unit.	
--	--

2. Product Description

2.1.Parameters

Frequency	1.400GHz-1.495GHz, 2.4GHz-2.483GHz, (Customizable)
Band width	2.5MHz (uplink), 10MHz(downlink)
Power	27dBm (FCC), 20dBm (CE)
Video format	720p@30fps, 720p@60fps, 1080p@30fps, 1080p@60fps
Modulation	OFDM
Constellation	BPSK, QPSK, 16QAM
FEC	LDPC (1/2, 2/3, 3/4, 5/6)
Duplex	TDD
Downlink throughput	2.3Mbps ~ 12Mbps
Uplink throughput	115.2kbps
Encryption	AES 128, AES 256
Interface	HDMI, USB, Serial, Ethernet, PPM/S.BUS
Dimension	77.8X47.3X23.5mm (Air unit)
	130X90X28.5mm (Ground unit)
Weight	97g(air unit)
Rated voltage/current	DC12V/1.2A (or 3S lithium battery)
Working temperature	-20°C ~55°C

2.2.Air Unit Interfaces

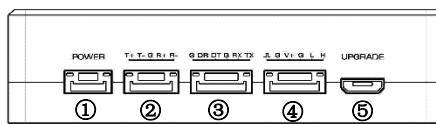

① Power Input Port

Connect a 12V power source to this port. The power source can be from a battery, or can be from a power adaptor when the ground unit is upgraded on the ground. The power supply recommended 3s battery.

② RJ45 Port

Connect the ethernet output of camera to the ethernet input of the air unit.

③ Serial Port (UART)

Connect this port to the telemetry port of a flight controller for telemetry communication with the ground unit. UART signal: LVCMOS-3.3V.

④ Remote Control Port (RC)

Connect this port to the PPM/S.bus port of a flight controller for remote control communication with the ground unit. Pin V + can provide 5V power supply.

⑤ Micro USB Port

Connect this port to the USB port of a PC or Laptop, and use the Taisync PC program to upgrade firmware on the air unit.

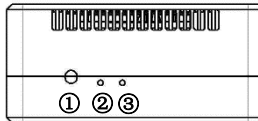

① Bind Button

Press this button to perform the binding operation.

② LED 1

When this LED is on, it means the air-to-ground link is connected; when this LED is off, it means the air-to-ground link is disconnected. (Not available for air unit)

③ LED 2

When this LED is on, it means the ground -to-air link is connected; when this LED is off, it means the ground-to-air link is disconnected. (Not available for air unit)

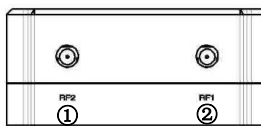

① RF2 Port

Connect the 2nd air unit antenna to this port.

② RF1 Port

Connect the 1st air unit antenna to this port.

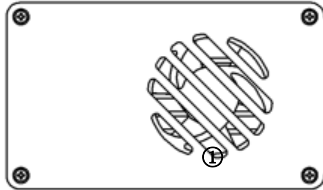

① Fan Ventilation Outlet

Don't block this fan ventilation outlet to ensure effective cooling.

2.3.Ground Unit Interfaces

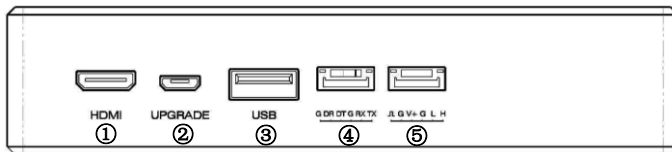

① HDMI Port

Connect this mini HDMI output port to the HDMI input port of a display device using the supplied Mini HDMI to HDMI cable.

② Micro USB Port

Connect this port to the USB port of a PC or Laptop, and use the Taisync PC program to upgrade firmware and set parameters on the air unit.

③ USB Port

Connect this port to the Lightning port of an iPhone, or to the USB port of an android phone and use ViULinx™ cell phone APP to watch live video play and set parameters of the air and ground unit. Video output interface can be connected to mobile phones or tablets for video play. QGC is also supported.

④ Serial Port (UART)

Connect this port to the telemetry port of a remote controller, or the serial port of a ground control station to setup a telemetry link between the drone and the remote controller or the ground control station. UART signal: LVCMOS-3.3V.

⑤ Remote Control Port (RC)

Connect this port to the training PPM/S.bus port of a remote controller. Remote controller can use ViUlinx™ uplink to communicate with the drone. Pin V + can provide 5V power supply.

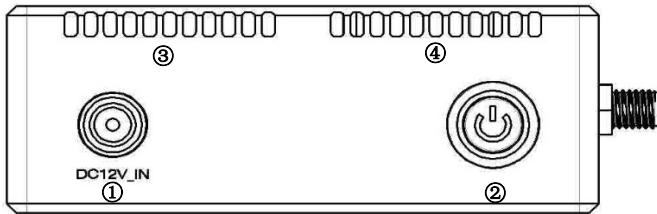

① Charging Port

Connect this port to the supplied power adaptor to charge the battery in the ground unit. The power supply recommended 3s battery.

② Power Button

When the ground unit is off, push this button once to turn on the ground unit. When the ground unit is on, push this button once to turn off the ground unit.

③ Fan Ventilation Outlet

Don't block this fan ventilation outlet to ensure effective cooling.

④ Fan Ventilation Outlet

Don't block this fan ventilation outlet to ensure effective cooling.

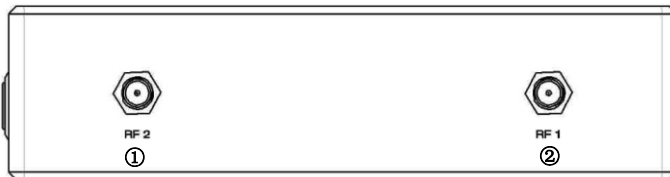

① RF2 Port

Connect the 2nd ground unit antenna to this port.

② RF1 Port

Connect the 1st ground unit antenna to this port.



① Bind Button

Press this button to perform the binding operation.



① LED 1

When this LED is on, it means the ground-to-air link is connected; when this LED is off, it means the ground-to-air link is disconnected.

② LED 2

When this LED is on, it means the air-to-ground link is connected; when this LED is off, it means the air-to-ground link is disconnected.

3. Installation

3.1. Air Unit Installation

3.1.1. Antenna installation

◆ 2.4G air unit

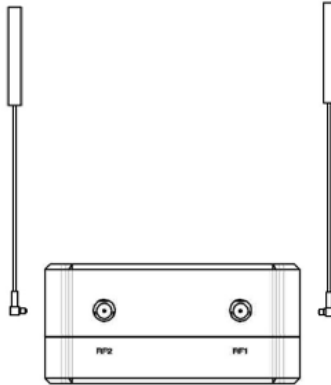

Insert the air unit antennas into the RF ports. Antenna clicks in when properly installed.

◆ 1.4G air unit

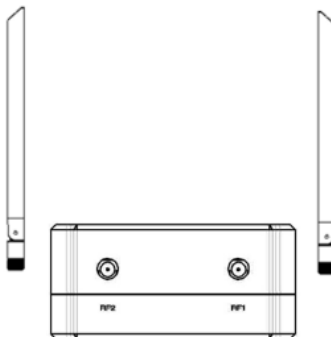

Insert the air unit antennas into the RF ports with RF cables. RF cables clicks in when properly installed.

Note:

(1) To avoid equipment damage, install antennas before powering on the units.

- (2) When install air unit to drone, avoid the antennas being blocked by parts of the drone.
- (3) Both antennas need to be installed.
- (4) Ensure the antenna connector is vertical to the module when it is pushed into the RF port.
- (5) When uninstall the antenna, hold the connector and pull it out of the RF port. Do not pull the cable.

3.1.2. Power supply

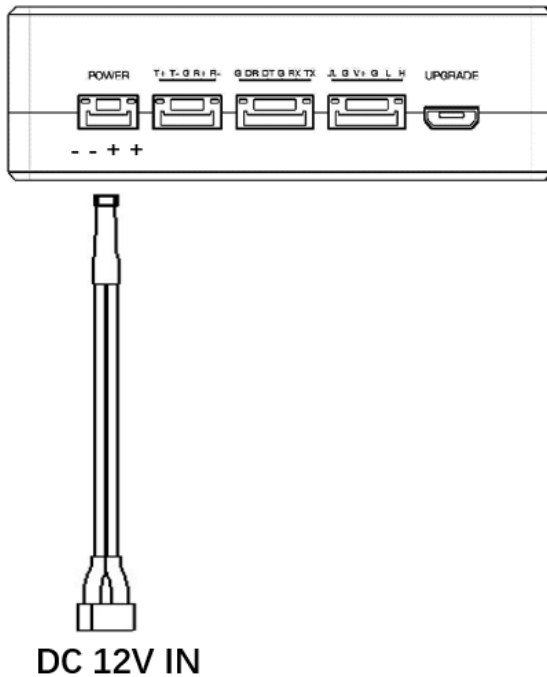

Pin-out: - - + +. Insert the four-pin connector of supplied power cable to the power port of the air unit and connect the orange power connect of supplied power cable to a battery output, or the power supply port of a drone. Recommended voltage is 12V.

Note:

- (1) To avoid equipment damage, install antennas before powering on the units.
- (2) Recommended rated voltage/current is DC12V/1.2A (or 3S lithium battery).

3.1.3. Connection to camera

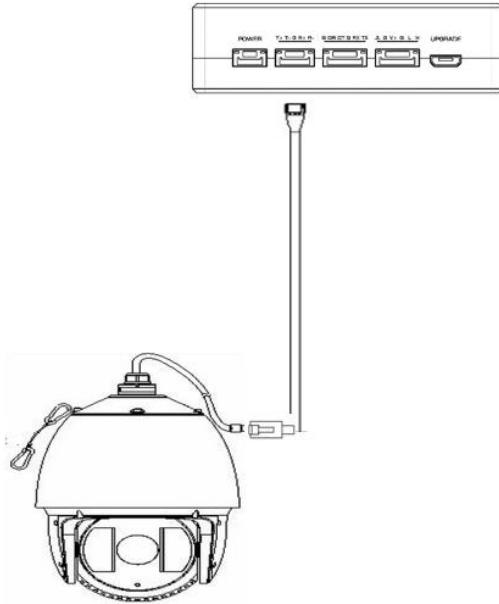

Connect the ethernet video output port to the serial video input port of the air unit.

3.1.4. Connection to flight controller (RC & telemetry)

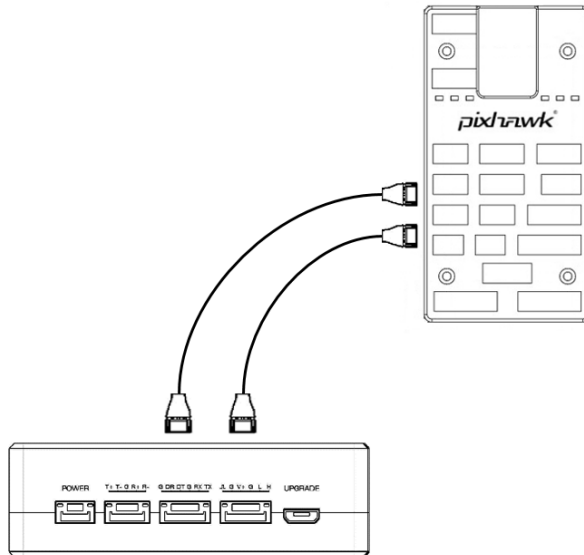

Insert the six-pin connector of supplied serial cable to the serial port of the air unit and connect the other end of the serial cable to the telemetry port of a flight controller.

Insert the supplied RC cable to the RC port of the air unit and connect the other end of the RC cable to the PPM/S.BUS port of a flight controller.

3.2. Ground Unit Installation

3.2.1. Antenna installation

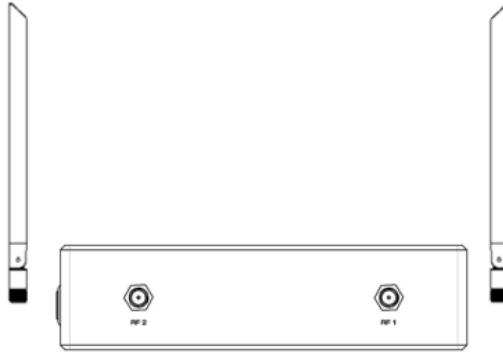

Screw the ground unit antennas onto the RF ports. Make sure the antennas are tightly installed.

Note:

- (1) To avoid equipment damage, install antennas before powering on the units.
- (2) Ensure the antenna connector is vertical to the module when it is screwed onto the RF port. Screw the antenna tightly to avoid loose connection, but do not overtighten the antenna to avoid damaging the antenna.
- (3) Both antennas need to be installed.
- (4) Adjust the antenna to be vertical to the ground during operation.

3.2.2. Power supply

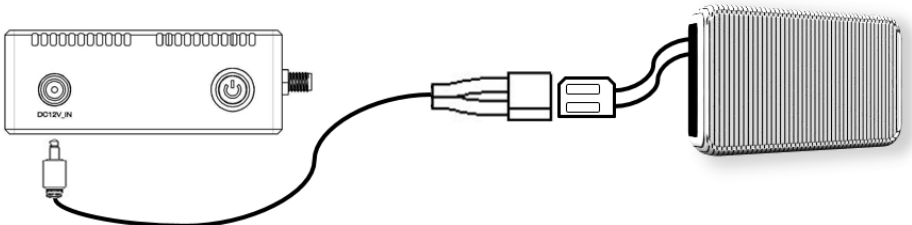

Insert the power connector of the power adaptor into the charging port of the ground unit and insert into the aerial plug into an electrical outlet to fully charge the battery of ground unit. Recommended voltage is 12V.

Note:

- (1) Recommended rated voltage/current is DC12V/1.2A (or 3S lithium battery).
- (2) To avoid equipment damage, install antennas before powering on the units.

3.2.3. Telemetry connection

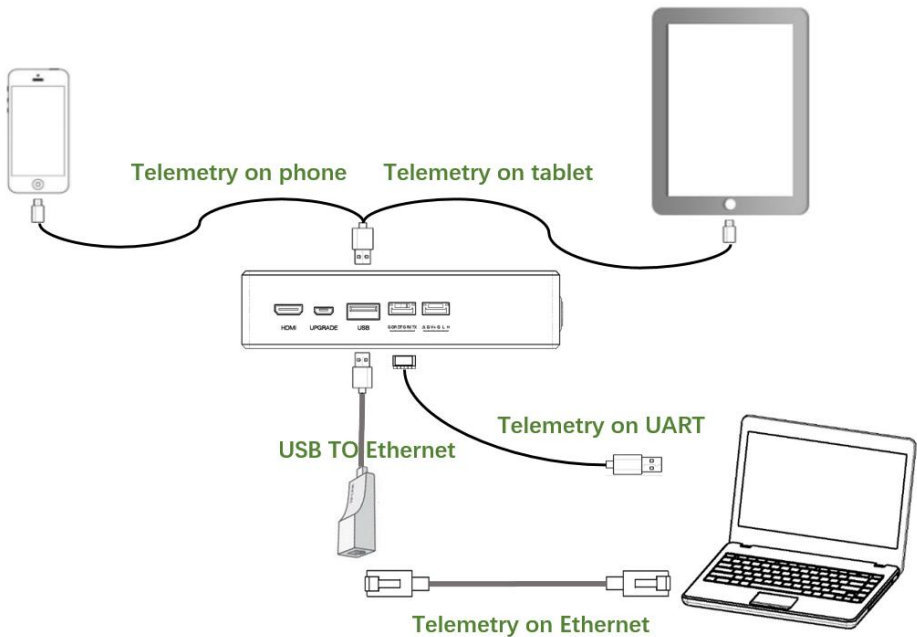

Insert the six-pin connector of supplied serial cable to the serial port of the ground unit and connect the other end of supplied serial cable to the telemetry port of the ground control station.

Note:

- (1) Ensure the baud rate of ground station and the baud rate of Taisync module are configured correctly.
- (2) Ensure the serial cable sequence matches the interface definition of Taisync module.

3.2.4. Connection to remote controller

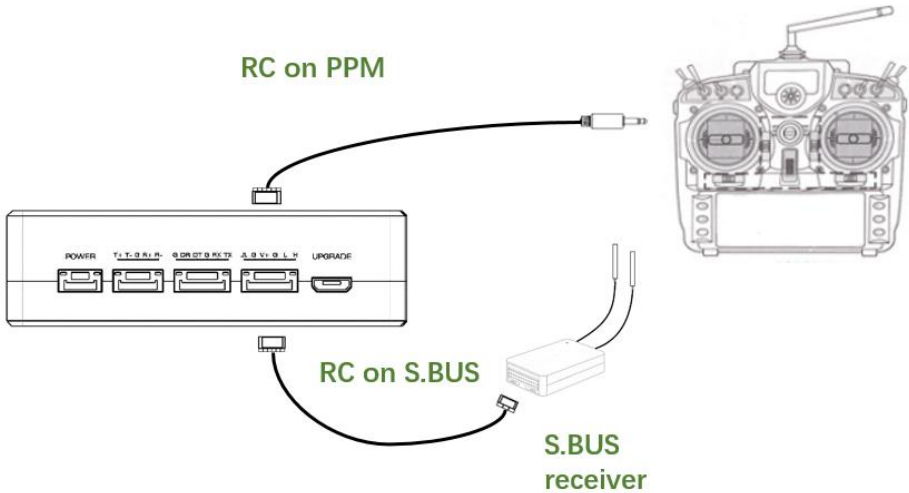

Using PPM mode: Insert the training connector of the supplied RC cable to the training port of a remote controller and connect the six-pin connector of the RC cable to the RC port of the ground unit.

Using S.BUS mode: Insert the six-pin connector of the RC cable to the RC port of the ground unit, the other end connect the S.BUS receiver, and the S.BUS receiver communicates with the remote controller in wireless communication.

Note:

- (1) Ensure the remote controller is in training mode, it is configured to the PPM or S.BUS working mode.
- (2) Ensure the RC cable sequence matches the interface definition of Taisync module.
- (3) If the S.BUS receiver is used, the working frequency of the receiver and the Taisync module should be guaranteed with a certain degree of isolation.

3.2.5. Setup video output

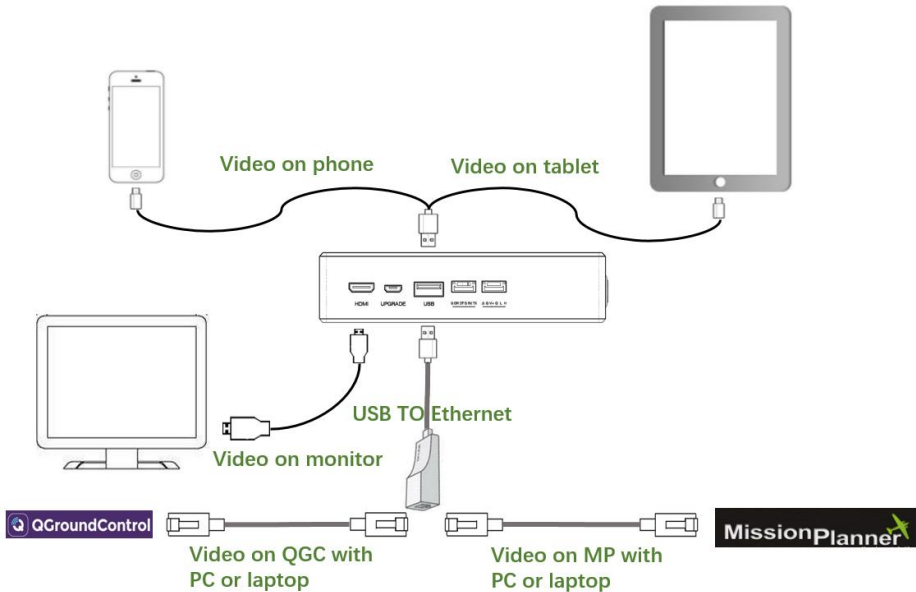

The ground unit outputs video to the monitor via HDMI cable, or you can connect the ground unit to the mobile phone or tablet via USB cable, and opens Viulinx APP to watch the video. QGC is also supported.

Video outputting can be supported on QGC or MP by using USB-Ethernet connector and connecting PC or laptop through ethernet cable.

Note:

- (1) If you use mobile phones or tablets to watch videos, please use Taisync's APP Viulinx. QGC can also be supported.
- (2) Using the USB-Ethernet connector, the corresponding ground station configuration is needed.

3.2.6. Use Taisync system

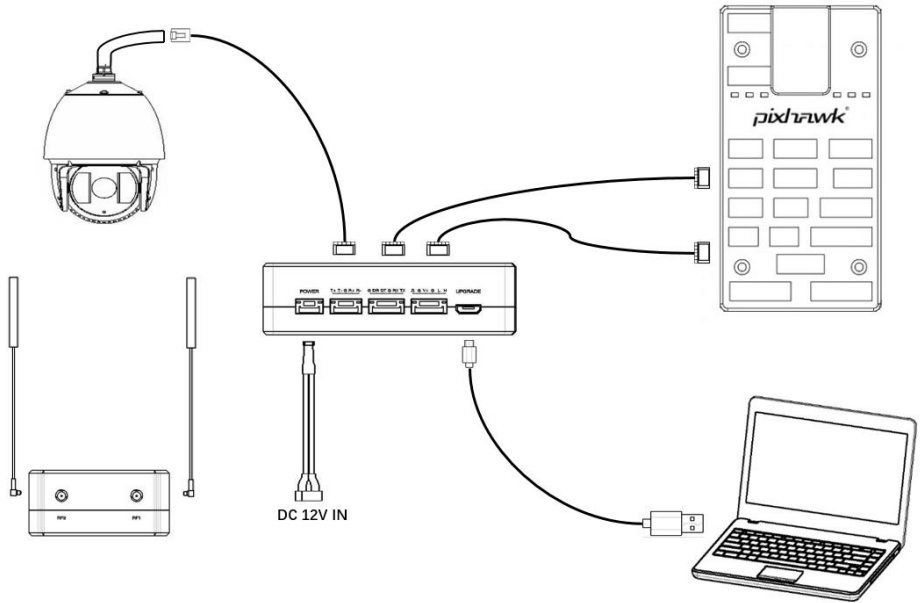

1. Connect antennas to RF ports of the air unit.
2. Connect camera ethernet output to ethernet input port of the air unit.
3. Connect the PPM/S.BUS port of the flight controller to the RC port of the air unit.
4. Connect the flight controller telemetry port to the serial port of the air unit.
5. Turn on the camera and set the video format.
6. Connect a 12V DC power to the power port of the air unit and turn on the power.
7. If latest firmware is desired, connect the air unit to a PC or a Laptop using USB cable and run Taisync PC program to upgrade the firmware of the air unit to the latest one.

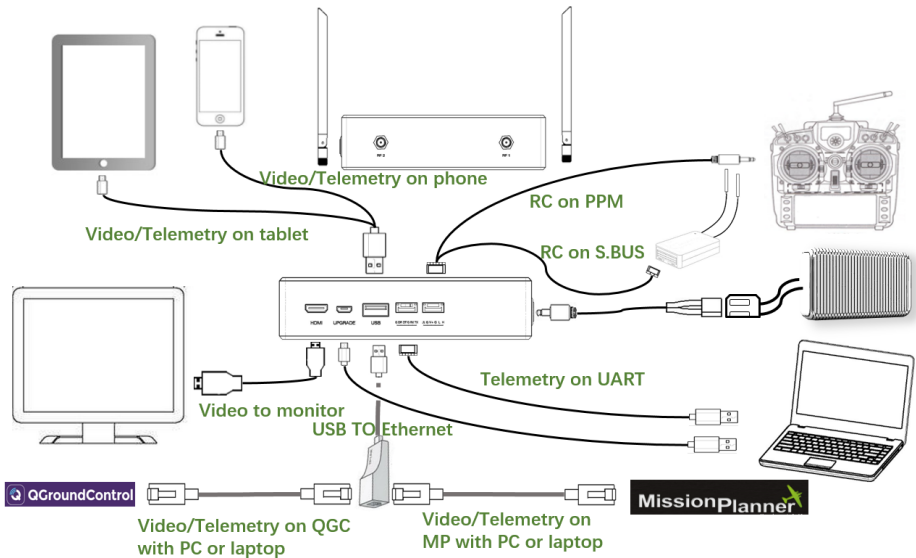

1. Connect antennas to RF ports of the ground unit.
2. Adjust the remote controller to the training mode, if PPM mode is used, the remote controller interface at the ground end is connected to the training port of the remote control. If S.BUS mode is used, the cable connection between the S.BUS receiver and the ground end need to be established, and the connection between the receiver and the remote control need to be established.
3. Connect the USB port of ground control station to the serial port of the ground unit with TTL-USB cable if you want to use Taisync's telemetry uplink.
4. Connect a phone or tablet to the USB port of the ground unit.
5. If video view on a monitor is desired, connect a monitor to the HMDI port of the ground unit.
6. Turn on the ground unit.
7. If latest firmware is desired, connect the ground unit to a PC or a Laptop using USB cable and run ViULinx™PC program to upgrade the firmware of the air unit to the latest one.
8. After downlink and uplink are connected, both LEDs will be on.
9. Run ViuLinX™ APP on your phone or tablet. QGC is also supported. You can watch the video on phone or tablet with ViuLinX™ or QGC APP.

4. Software

4.1. Installation

We provide program installation files, program file name: Taisync Wireless App Setup.exe. The installer icon is as follows:

 **Taisync Wireless App Setup 1.02.exe**

Double-click the installer to install and customize the program installation directory. After configuration, click the “Next” button to jump to the next step. To cancel the installation, click the “Cancel” button.

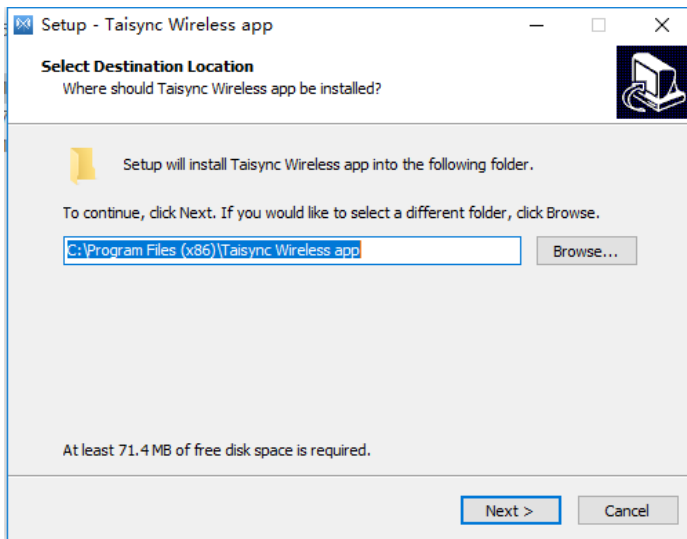

Check the Generate desktop shortcut. If it is not checked, the desktop shortcut will not be generated. After configuration, click the “Next” button to jump to the next step. To rewind the previous step, click the “Back” button. To cancel the installation, click the Cancel button.

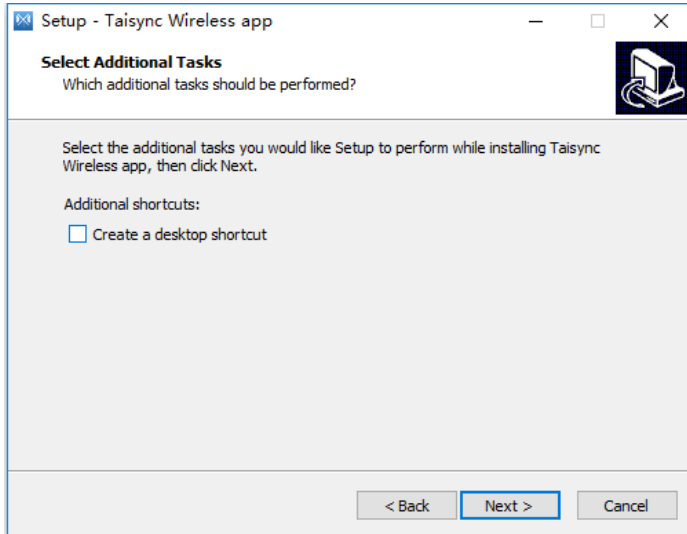

Click “Install” to proceed with the installation. To rewind the previous step, click the “Back” button. To cancel the installation, click the “Cancel” button.

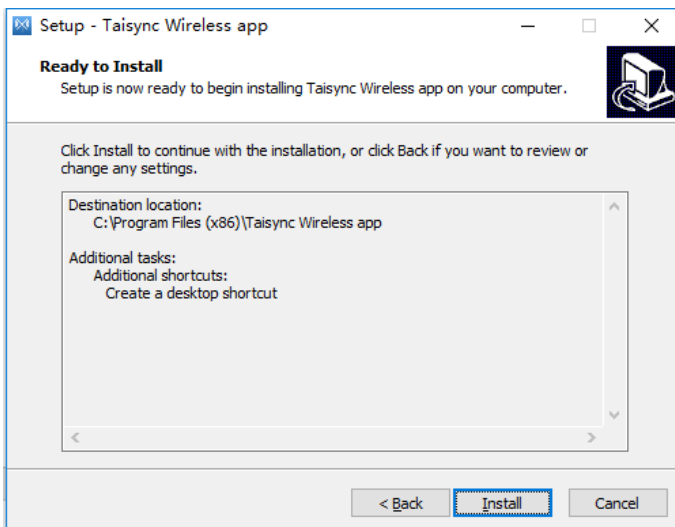

Note: Please turn off the firewall software, otherwise the firewall may prevent the driver from being installed when the driver is installed.

At this point, the software installation is successful and the driver installation is complete.

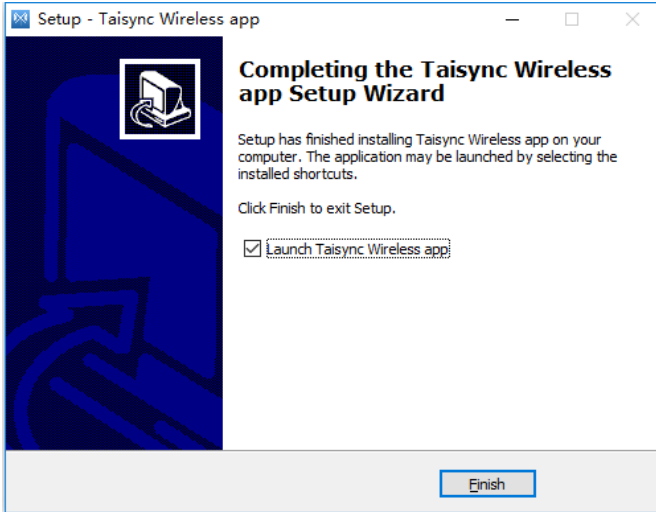





4.2. Software Language

Taisync PC software supports Chinese and English display, and the software is selected according to the operating system.

If the Chinese operating system will display the software in Chinese, the other operating systems will display in English.



	Device Type	Ground
	Software Version	V2.8
	Firmware Version	1.5.0
	Baseband Version	190415

SN:WAG198820127-c190415-a2003150-13338-decodeV2.5

4.3.Device Info

Readable device status information: device type, software version, firmware version, and baseband version.



	Device Type	Ground
	Software Version	V2.8
	Firmware Version	1.5.0
	Baseband Version	190415

S/N:WAG198820127-c190415-a2003150-13338-decodepV2.5

4.4.Status

Read the air and ground status information, can read double-ended information: RSSI (received signal strength indication), Tx_Power.

Air Status

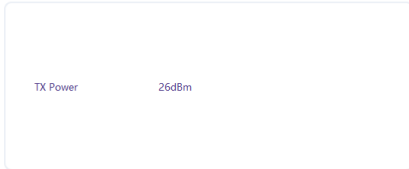
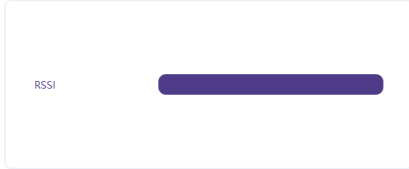

Ground Status

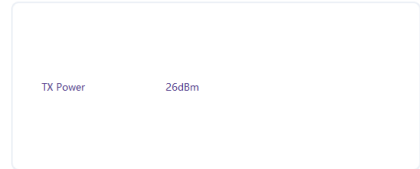

4.5. Configuration

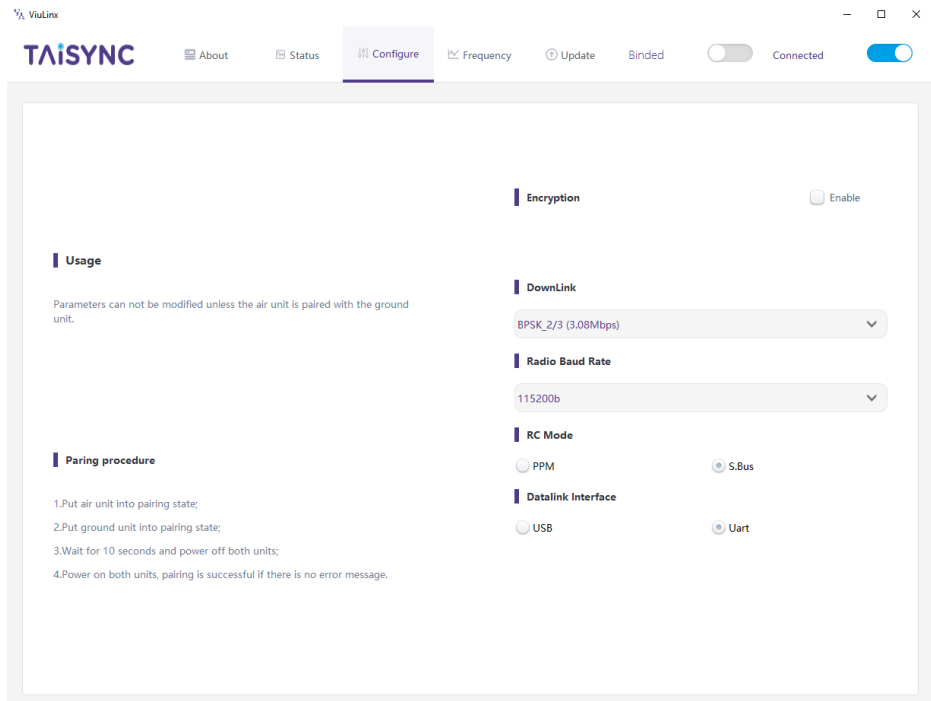

4.5.1. Encryption configuration

Check "enable" to turn on AES encryption, we can choose AES128 or AES256.



4.5.2. Mode configuration

For parameter configuration, device bind is required.

Usage

Parameters can not be modified unless the air unit is paired with the ground unit.

Pairing procedure

- 1.Put air unit into pairing state;
- 2.Put ground unit into pairing state;
- 3.Wait for 10 seconds and power off both units;
- 4.Power on both units, pairing is successful if there is no error message.

Encryption

Enable

DownLink

BPSK_2/3 (3.08Mbps) ▾

Radio Baud Rate

115200b ▾

RC Mode

PPM

S.Bus

Datalink Interface

USB

Uart

The downlink mode adjustment interface is as follows:

DownLink

2.31Mbps ▾

- 2.31Mbps
- 3.08Mbps
- 3.47Mbps
- 3.86Mbps
- 4.63Mbps
- 6.17Mbps
- 6.94Mbps
- 7.71Mbps
- 9.25Mbps
- 13.88Mbps
- 23.13Mbps

4.5.3. Baud rate configuration

Supported baud rate configuration: 9600, 57600, 115200, 230400, 460800.

Radio Baud Rate

A dropdown menu for 'Radio Baud Rate' configuration. The current selection is '57600b'. The menu is open, showing a list of options: 9600b, 57600b (highlighted in blue), 115200b, 230400b, and 460800b.

4.5.4. Telemetry configuration

Telemetry supported that can be on UART or USB.

Datalink Interface

Two radio buttons for 'Datalink Interface' configuration. The 'USB' button is unselected, and the 'Uart' button is selected (indicated by a blue dot).

Supported baud rate configuration: 9600, 57600, 115200, 230400, 460800.

Radio Baud Rate

A dropdown menu for 'Radio Baud Rate' configuration. The current selection is '115200b'. The menu is open, showing a list of options: 9600b, 57600b, 115200b (highlighted in blue), 230400b, and 460800b.

4.5.5. Remote control mode configuration

Supported remote control mode: PPM, S.bus.

RC Mode

PPM

S.Bus

4.6. Frequency Scan

The left side is the frequency scan curve after the module starts. This interface display the current working frequency, adjust the working frequency, adjust the frequency working mode, the working region (FCC, CE) and the maximum TX power.

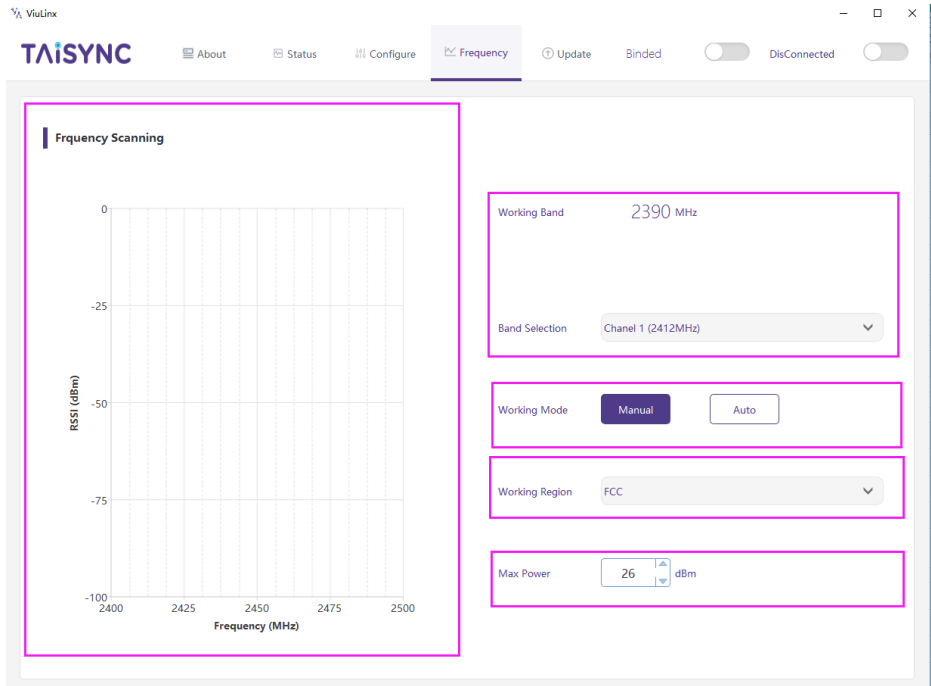

Working Mode : Manual, Auto.

Working Mode

Manual

Auto

Manual mode: The module administrator or user manually configures the working frequency.

Auto mode: The system configures the working frequency according to the frequency scan curve.

Band Selection

Chanel 1 (2412MHz)

Working Mode

Chanel 4 (2427MHz)

Chanel 5 (2432MHz)

Chanel 6 (2437MHz)

Chanel 7 (2442MHz)

Chanel 8 (2447MHz)

Chanel 9 (2452MHz)

Chanel 10 (2457MHz)

Chanel 11 (2462MHz)

Chanel 12 (2467MHz)

Chanel 13 (2472MHz)

4.7.Upgrade

Note: air and ground upgrades need to be upgraded separately using the USB cable to connect Taisync PC software.

Select the upgrade file, click the Upgrade button to upgrade.

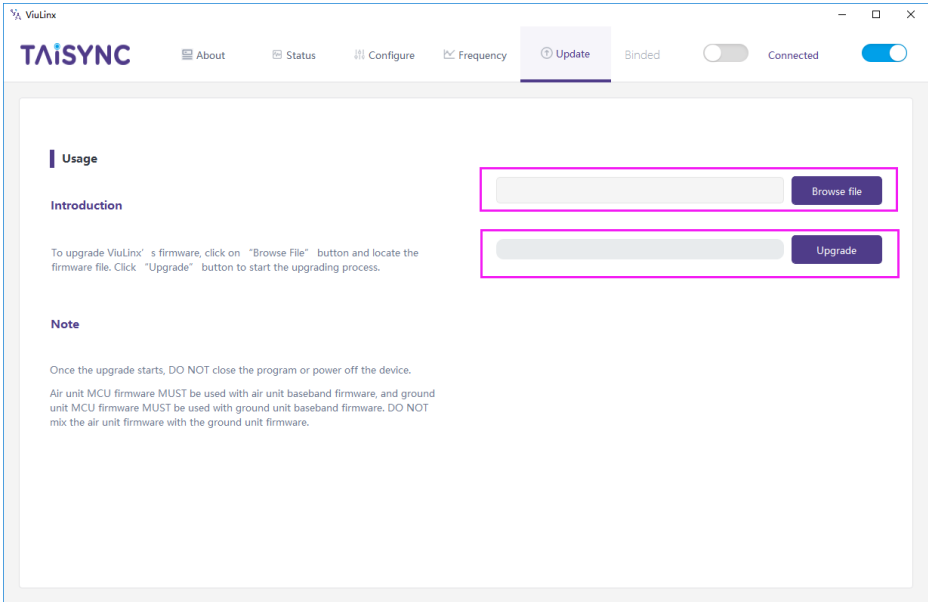

4.8. View Live Video

Set the IP address of camera to 192.168.0.2. Change user name to admin, Change password to 12345678. The default video connection is rtsp://192.168.0.2:554.

If the port is different, or RTSP Rui has a path, it needs to be modified by QGC to adapt the camera.

4.8.1. On phone/tablet

Connect cell phone to the micro USB port of the ground unit. Run ViULinx™ APP on your cell phone. QGC is also supported.

4.8.2. On monitor

Connect a monitor to the HDMI port of the ground unit.

5. Applications

5.1. Applications of system in detail

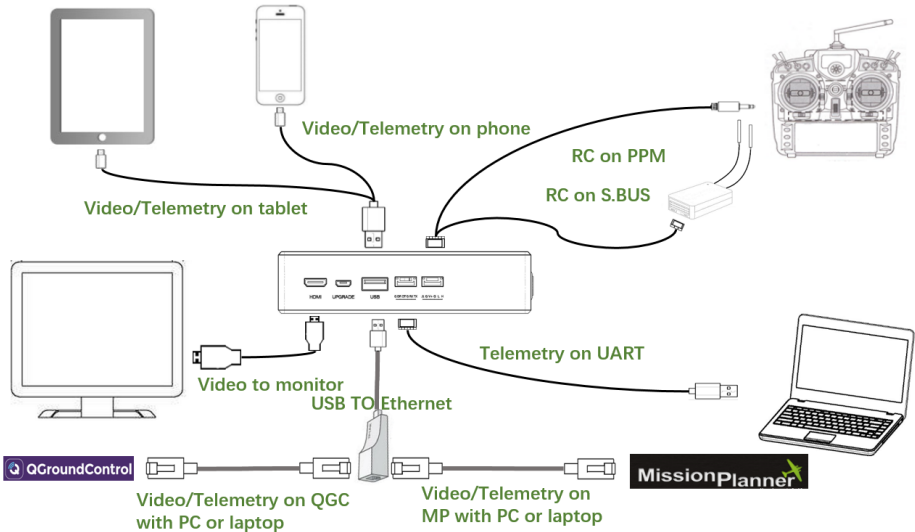

5.2. Applications of RC

The remote control function can support PPM and S. BUS protocol.

If PPM mode is used, please use Taisync standard PPM cable to connect the ground unit and the remote controller's training port.

If S. BUS mode is used, additional receiver supporting S. BUS is needed. The ground unit is connected with the receiver. The S. BUS receiver establishes wireless communication with the remote controller.

Both modes require the remote controller to configure the corresponding mode.

If using S. BUS receiver, please use a receiver which working frequency is different from Taisync module.

When using PPM mode, the air unit needs to connect the PPM RC port of Pixhawk4.

When using S. BUS mode, the air unit needs to connect the DSM/S. BUS RC port of Pixhawk4.

5.2.1. FRISKY remote controller

✚ PPM mode

Model setup - Trainer - mode, if mode is configured to Slave/Jack, then the remote controller is in PPM mode.

Model setup - Internal RF, it is needed to be configured to off, S. bus mode will be closed.



✚ S.BUS mode

Model setup - Internal RF: LR12, D8, D16, OFF. Configuration of different parameters is according to the receiver. If configured as off, S. bus mode will be closed.



5.2.2. Futaba remote controller

✚ S.BUS mode

Linkage menu - system: FASSTest-14CH, FASSTest 12CH, FASST MULTI, FASST 7CH, S-FHSS. Configuration of different parameters is according to the receiver.



✚ PPM mode

Taisync standard PPM cable is used to connect with Futaba trainer cable (one end is connected to the trainer port of futaba, the other end is 3.5mm connector). PPM mode can be used directly without additional configuration.

5.3. Telemetry connection

The telemetry Port of air unit connects “TELEM1” Port of flight control (Pixhawk4).

5.4. Video output on USB (standard)

Standard mode: connect to mobile phone or tablet with USB cable, display video with Viulinx APP of Taisync.

Taisync also supports video display on QGC APP (mobile phones and tablets) and telemetry on QGC.

6. Notes

6.1. Link performance

- Interference by 2.4GHz WiFi

WiFi operates at 2.4GHz band with bandwidths of 20MHz and 40MHz. WiFi can generate both co-channel interference and adjacent channel interference to the 2.4GHz wireless link of a drone. Even if there is not a WiFi router is available for a WiFi device (for example, WiFi of a phone) to connect with, a WiFi device periodically transmits beacon/probe signals. So, when you operate a drone in the field with 2.4GHz wireless link, it is important to turn off WiFi modem/hotspot of a phone, or a laptop. If WiFi relay of the video from the ground station is desired, it is recommended to use a 5.8GHz WiFi modem.

● Interference by Bluetooth device

Bluetooth operates on 2.4GHz in frequency hopping mode. So a Bluetooth mouse, Bluetooth joystick, or any Bluetooth device that is actively working and next to ground station will interfere the reception of downlink video. Please avoid using Bluetooth device when operate a drone with 2.4GHz wireless link.

● Interference by wireless device in co-existence

Another wireless device that operates on bands close to 2.4GHz and the device is placed close to the drone's 2.4GHz wireless module can interfere the drone's wireless link. For example, some drones have both LTE link and point-2-point wireless link. Particularly, the LTE operating on 2.3GHz band can be a problem. If the antenna of the LTE module is placed close to the antenna of the 2.4GHz point-2-point wireless module, the receiver of 2.4GHz module can be saturated by the LTE signal when it is transmitting. Thus, the range/performance of the 2.4GHz module will be significantly degraded.

● Interference by HDMI

When HDMI source/cable is close the antenna of 2.4GHz wireless modem, the HDMI source/video will interfere the 2.4GHz wireless signal (including WiFi).

<https://h30434.www3.hp.com/t5/Notebooks-Archive-Read-Only/HDMI-interfering-with-WiFi-connectivity/td-p/4535026>

<http://www.dslreports.com/forum/r27141612-HDMI-connect-interferes-with-wifi>

It is recommended that install the antenna at least 25cm away from the HDMI source/cable. A good shield HDMI cable can be a resolution too. The following shield HDMI cable uses 360-degree shield termination, which is recommended practice.

<https://interferencetechnology.com/hdmi-cables-emi/>

<http://www.l-com.com/content/Article.aspx?Type=P&ID=10699>

<http://www.l-com.com/audio-video-micro-hdmi-to-hdmi-cables>

<http://www.l-com.com/audio-video-hdmi-female-to-micro-hdmi-male-adapter>

● RF cable connector/Antenna connector check

Before flight, check if the antennas are connected to the modules. Running module without antenna connected results in very short range and potentially can damage the module. It is recommended to check the connection of all RF connectors. Loose connection can degrade the range significantly.

● Antenna placement

Place the two air antennas so that no matter what position the drone is, at least one antenna is not blocked by the payload from the ground station.

If the drone will fly in full throttle, it will lean forward. Install the air antenna so that it is close to be vertical to the ground when the drone moves forward in full throttle.

● Battery level of ground station

The reception performance will degrade if the battery of ground station runs low, even though it might still power the wireless ground unit up.

6.2.How to select Frequency

Click “Frequency” button using Viulinx APP.



Device Type	Ground
Software Version	V2.6LT
Firmware Version	1.4.11
Baseband Version	181016

SN:c181016-a20014b-11327

On the left, you can see the RSSI curve of frequency scan.

Scan range: 2.4G WIFI bands.

The lower the RSSI value of the corresponding frequency points, the lower interference.

Please select the lowest interference frequency.

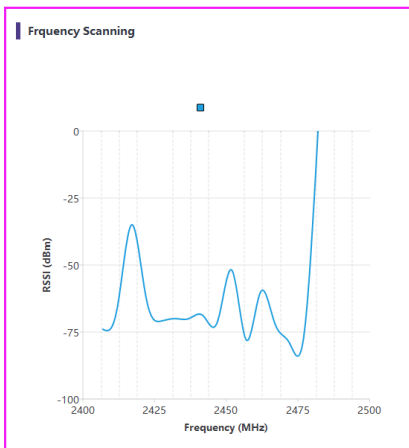

Working Band 2495 MHz

Band Selection Channel 1 (2412MHz)

Working Mode Manual Auto

Working Mode : Manual, Auto.

Working Mode

Manual

Auto

Manual mode: The module administrator or user manually configures the operating frequency.

Auto mode: The management software configures the optimal working frequency according to the frequency scan information.

Please make sure working mode is on manual mode.

Band Selection

Chanel 1 (2412MHz)

Chanel 1 (2412MHz)

Chanel 2 (2417MHz)

Chanel 3 (2422MHz)

Chanel 4 (2427MHz)

Chanel 5 (2432MHz)

Chanel 6 (2437MHz)

Chanel 7 (2442MHz)

Chanel 8 (2447MHz)

Chanel 9 (2452MHz)

Chanel 10 (2457MHz)

Working Mode

We can select working frequency by band selection function.

We provide 2390MHz and 2495MHz reserved frequency.

If WiFi interference is too high, you can consider using reserved frequency.

Working Mode

Chanel 10 (2457MHz)

Chanel 11 (2462MHz)

Chanel 12 (2467MHz)

Chanel 13 (2472MHz)

Chanel RSV (2390MHz)

Chanel RSV (2495MHz)

6.3.Firmware update

Upgrade files: FPGA upgrade file for air unit, FPGA upgrade file for ground unit, MCU1 upgrade file for air unit, MCU1 upgrade file for ground unit, MCU2 upgrade file for air unit, MCU2 upgrade file for ground unit, Hi3516 upgrade file for air unit, Hi3798 upgrade file for ground unit.

Hi3798 upgrade file for ground unit is upgraded with U disk. The fastboot. bin file needs to be added to the root directory of the U disk, and the upgrade file is renamed update. bin. When the ground unit is powered on, insert the U disk into the USB port. The LED lamp of the ground unit will appear green flashing, indicating that it is in the upgrade process. When upgrade is completed, the LED lamp will no longer flashing. The upgrade process is expected to last 7-8 minutes.

Other files are upgraded using management software. During the upgrade process, the power can not be powered off and the normal connection of USB cable should be ensured at the same time. If the upgrade fails, the power can not be powered off, please try to upgrade again directly. Otherwise, it will be necessary to return to us to use special burning tools for firmware burning.

6.4.Bind operation

“Bind” is used to pair an air unit with ground unit.

To pair an air unit and an ground unit:

1. Both air unit and ground unit are powered on.
2. Connect the air and ground unit.
3. Press the physical bind button of the air unit, last 3-5s. The LED light next to the bind button flashes green, indicating that it is in the binding state.
4. Press the physical bind button of the ground unit, last 3-5s. The LED light next to the bind button flashes green, indicating that it is in the binding state.
5. When the link indicator LEDs of ground unit are always on, it indicates that the air and ground unit is binded. Then power off both units.
6. Power on both units. Link indicator lights are always on, indicating bind operation of the air and ground units are completed.

Note:

- (1) If modules binding with different firmware version, the binding operation may fail.

(2) If the program of the air unit or the ground unit is burned incorrectly, such as burning the air unit to the ground unit, and performing the binding operation between the wrong air unit and the ground unit, the binding operation will fail.

6.5. Telemetry & RC

Telemetry

UART signal: LVCMOS-3.3V.

Pin-out: G DR DT G RX TX.

Debug-DR/DT, Telemetry-RX/TX.

RC

Pin-out: II G V+ G L H.

II: PPM/SBUS G: GND V+: POWER(5V) G: GND L: CAN-bus-L

H: CAN-bus-H (CAN-bus is not supported yet).

The RC port can provide 5V power supply for S. BUS application.

7. FAQ

Q1: How to install management software and driver, and how to use management software?
Please read Chapter 4 of this document.
Q2: How does the Taisync module supply power?
Air unit: DC, power supply range: 8-15V, recommended to use 12V, Taisync provides power supply cables.
Ground unit: DC, power supply range: 8-15V, recommended to use 12V, Taisync provides power supply cables.
Q3: Can the Taisync module be powered on before antennas installation?
The antennas must be installed before power on.
Q4: How many antennas do Taisync's air unit need to be installed?
Two antennas need to be installed.
Q5: How many antennas do Taisync's ground unit need to be installed?
Two antennas need to be installed.

Q6: Can different types of remote controllers be used to control drone?
Yes, just output standard PPM signals through the coach port, or use S. BUS receiver.
Q7: Can two air units be installed on a drone?
No, a drone can only integrate one air unit.
Q8: Can two ground units be installed at the receiving end?
The ptp system can only install one ground unit; the ptmp system supports more than one ground units.
Q9: There are some devices nearby, such as WIFI, Bluetooth and so on. Can they be opened when flying?
Be sure to turn off WIFI, Bluetooth and other functions of other devices, because these devices are working in 2.4 GHz band, It can cause interference.
Q10: After integrating the Taisync air unit, GPS is not good at searching for stars. What should we do?
Please check whether the antennas of air unit is far away from GPS to avoid blocking interference to GPS. The frequency band of 1.4G module is close to working frequency of GPS, so it is necessary to ensure a certain degree of antenna isolation.
Q11: What do the two LED lights of the ground unit stand for?
LED 1 (downlink Indicator): The LED is on indicates that the air-to-ground link is connected; the LED is not on indicates that the air-to-ground link is disconnected.
LED 2(uplink Indicator): The LED is on indicates that the ground-to-air link is connected; the LED is not on indicates that the ground-to-air link is disconnected.
Q12: What do the two LED lights of the air unit stand for?
LED 1 (Ethernet Data Link Indicator): The LED is flickering indicates that the data link is connected; not flickering indicates that the data link is disconnected.
LED 2 (Ethernet Physical Link Indicator): The LED is on indicates that the data link is connected; not flickering indicates that the data link is disconnected.
Q13: What if the uplink LED indicator is not on?
Please follow the following steps:
1) Please check the power supply of the air and ground unit is normal.
2) Please check the antennas installation of the air and ground units is normal: whether the antennas is blocked; whether the antennas connection is loose; whether the rf cable and port is not tightened;
3) Check whether the TX frequency of the ground unit is consistent with the RX frequency of the air unit with Taisync PC management software.

4) Check the TX power of the ground unit with Taiysnc PC management software.

5) If the above steps can not solve the problem, please contact Taisync technical support staff.

Q14: What if the downlink LED indicator is not on?

Please follow the following steps:

1) Please check the power supply of the air and ground unit is normal.

2) Please check the antennas installation of the air and ground units is normal: whether the antennas is blocked; whether the antennas connection is loose; whether the rf cable and port is not tightened;

3) Check whether the TX frequency of the air unit is consistent with the RX frequency of the ground unit with Taiysnc PC management software.

4) Check the TX power of the air unit with Taiysnc PC management software.

5) If the above steps can not solve the problem, please contact Taisync technical support staff.

Q15: What if the ethernet physical link LED indicator is not on?

Please follow the following steps:

1) Please check whether the power supply of the air unit is normal.

2) Please check whether the RJ45 cable is normal.

3) If the above steps can not solve the problem, please contact Taisync technical support staff.

Q16: What if the ethernet datel link LED indicator is not on?

Please follow the following steps:

1) Please check whether the ethernet physical link LED indicator is on.

2) Please check whether the cameras, pods and other equipment are working properly.

3) If the above steps can not solve the problem, please contact Taisync technical support staff.

Q17: After connecting Taisync module, telemetry can not be connected properly?

Please follow the following steps:

1) Please check whether the link state is normal, please refer to Question 12 and Question 13 if it is abnormal.

2) Please check whether the telemetry port both the air and the ground units is correct.

3) Please check whether the connecting between flight controller and air unit is correct and that between ground unit and ground station is correct.

4) Please check whether the telemetry connection of the air and ground unit is correct. We provides standard cables. If you make it by yourself, please check the pin.
5) Check whether the baud rate is configured correctly with Taisync PC management software.
6) If the above steps can not solve the problem, please contact Taisync technical support staff.
Q18: After connecting Taisync module, RC can not be connected properly?
Please follow the following steps:
1) Please check whether the link state is normal, please refer to Question 12 and Question 13 if it is abnormal.
2) Please check whether the RC port both the air and the ground units is correct.
3) Please check whether the RC connecting between flight controller and air unit is correct and that between ground unit and remote contriller is correct.
4) If using PPM mode, check the mode configuration of the remote controller; if using S. BUS mode, check the configuration of the receiver and remote controller;
5) Please check whether the RC connection of the air and ground unit is correct. We provides standard cables. If you make it by yourself, please check the pin.
6) Please check whether the RC mode is configured correctly with Taisync PC management software.
7) If the above steps can not solve the problem, please contact Taisync technical support staff.
Q19: After connecting Taisync module, video can not be output properly?
Please follow the following steps:
1) Please check whether the link state is normal, please refer to Question 12 and Question 13 if it is abnormal.
2) Please confirm whether the ethernet physical link and the ethernet data link indicators are normal, if not, please refer to Question 14 and Question 15.
3) Please confirm the IP address, login username and password of the webcam;
4) Please check whether the phone or HDMI connection is correct, and whether Viulinx APP is used;
5) If the above steps can not solve the problem, please contact Taisync technical support staff.
Q20: After connecting Taisync module, what if the video carton or mosaic?
Please follow the following steps:
1) Please confirm whether the downlink mode configuration is reasonable;

2) Please check whether the connection of RJ45 network is normal;

3) Please check If there is interference exist, we can consider changing the working frequency.

4) If there is no interference, whether the limit distance of communication link has been reached;

5) If the above steps can not solve the problem, please contact Taisync technical support staff.

Q21: After connecting Taisync module, what if the transmission distance of the module is short, which is not up to expectation.?

Please follow the following steps:

1) Please verify whether the antenna and RF cable are installed correctly, check whether they are Taisync standard materials;

2) Please ensure that the antennas installation of air unit is not blocked by the payload, and there is no obvious blocking at the ground unit near the antennas, and the antennas of the air and ground units are perpendicular to the ground;

3) Please check whether the RF power is reduced, not to achieve full RF power;

4) Please check whether the downlink mode configuration is reasonable or not, the high-speed downlink mode will significantly reduce the transmission distance;

5) Please check whether the working frequency is obviously interferenced or not, Chapter 6.2 introduces how to select working frequency.

6) Please check whether there is serious obstruction between the air and the ground unit during flighting, and the complex geographical environment will affect the transmission distance;

7) If the above steps can not solve the problem, please contact Taisync technical support staff.